

# 3D-Simulation of Action Potential Propagation in a Squid Giant Axon

Revathi Appali<sup>1\*</sup>, Sabine Petersen<sup>1</sup>, Jan Gimsa<sup>2</sup> and Ursula van Rienen<sup>1</sup>

<sup>1</sup>Institute of General Electrical Engineering, Chair of Electromagnetic Field Theory, University of Rostock, Germany

<sup>2</sup>Institute of Biology, Chair of Biophysics, University of Rostock, Germany

\*Corresponding author: Justus-von-Liebig-Weg 2, 18059, Rostock, Germany

revathi.appali@uni-rostock.de

**Abstract:** Study of neurons plays a key role in the fields of basic and medical research aiming at the development of electrically active implants. The Fitzhugh-Nagumo equations are used to model and simulate the spike generation and propagation in a squid giant axon using Comsol Multiphysics® 3.5a Software. It is shown that the Fitzhugh-Nagumo equations allow for a geometrical explanation of important biological phenomena related to neuronal excitability and spike-generating mechanisms.

**Keywords:** Action potential, squid giant axon, Fitzhugh-Nagumo equations, simulation

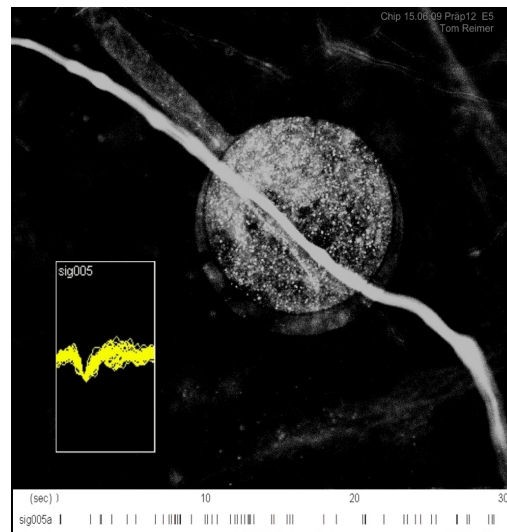
## 1. Introduction

Neurons are the key components of the complex nervous system. The major parts of a neuron are the cell body (*soma*), signal receiving ends (*dendrites*), signal transmitter (*axon*), and connecting ends to other neurons or glands (*synapses*). Neurons transmit information by firing and propagating electrical Action Potentials (AP) along their axons. Axons are neuronal parts which are roughly tubular. Usually, motor neurons possess a myelin sheath around their axons acting as an insulator and enhancing the speed of signal transmission.

Hodgkin and Huxley conducted their experiments on non-myelinated giant nerve fibers to study the neuronal properties. The AP observed in a neuron was explained as the result of (physiological processes) ion movement across the membrane of cell. The Hodgkin-Huxley equations [1] are the starting point for detailed neuronal models. They are employed to describe the experimental behavior by a system of partial differential equations.

Neurochips consist of a Micro-Electrode Array (MEA) which can be used to register signals from non-myelinated neurons or to stimulate these cells. Neurochips may be used in

medical research such as neuroprosthetic studies and for optimizing implants. The understanding of the nerve cell - electrode interactions are essential, e.g. in neuroprosthetic research on cochlear and retinal implants or deep brain stimulation. Figure 1 shows an axon on a single MEA electrode pad of a neurochip.



**Figure 1** Axon on an MEA-electrode in a neurochip and action potential signals recorded from the electrode (Image courtesy: Tom Reimer, Chair of Biophysics, University of Rostock, Germany)

### 1.1 Squid Giant Axon

The squid giant axon is a very large axon with a typically diameter of 0.5 mm (max. 1 mm). It controls part of the water jet propulsion system in the squid. These giant nerve fibers conduct electric signals faster than those of a smaller diameter. The reason is the higher conductance of the core which increases by the square of its diameter whereas the electrical capacity of the surface increases only by its first power [2].

## 2. Fitzhugh-Nagumo Model

The Fitzhugh-Nagumo model is a simplified form of the Hodgkin-Huxley model [3]. The Fitzhugh-Nagumo equations [5] are a complex system of nonlinear, partial-differential equations (PDE). In the model, the excitable system, i.e. the neuron, can be stimulated by an input, such as an electric current. The state of the excitation, when stimulated can be described by  $u_1$ , which represents the (excitation) voltage in the neuron as a function of time. When part of a neuron is excited, physiological processes will induce the recovery of the resting potential. The variable  $u_2$  in the model equations represents these recovery processes. The stimulus to the neuron is represented by electric potential  $I$ . The equations are given by:

$$\frac{\partial u_1}{\partial t} = \Delta u_1 + (\alpha - u_1)(u_1 - 1)u_1 + (-u_2) + I \quad (1)$$

$$\frac{\partial u_2}{\partial t} = \varepsilon(\beta u_1 - \gamma u_2 - \delta) \quad (2)$$

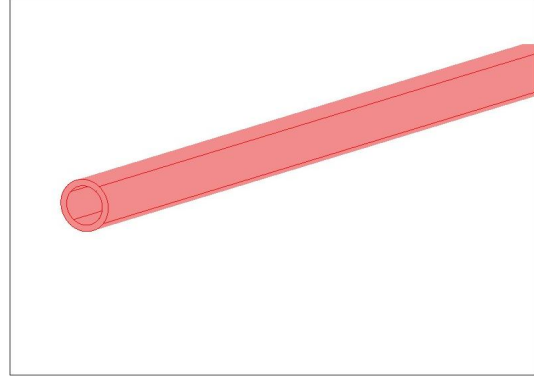
where  $\alpha$  is the excitation threshold and  $\varepsilon$  is the excitability.  $\beta$ ,  $\gamma$  and  $\delta$  are parameters effecting the resting state and dynamics of the system.

## 3. Numerical Simulations with COMSOL Multiphysics

### 3.1 Geometry

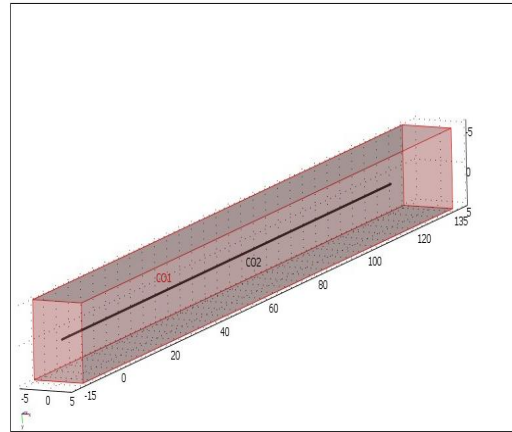
The three dimensional general form of Comsol's PDE modes is used to simulate the squid giant axon with Comsol Multiphysics® 3.5a. The original geometry of a squid axon is a hollow cylinder of 0.6 mm diameter with a membrane thickness of 3.5 nm and a length of 3 cm [4]. Due to numerical limitations, as a first simulation approach, a tubular cylinder with a diameter of 20 cm, a membrane thickness of 50 mm and length of 135 m are assumed. It is supposed that the numerical problems could be avoided if the code would allow for a scaling factor for the geometrical input.

Figure 2 shows a small section of the tubular axon model used in the simulation.



**Figure 2.** Small section of a tubular axon model

In accordance with the neurochip environment, the extra-cellular medium of the axon is modeled as a solid block of  $10 \times 10 \times 150 \text{ m}^3$  ( $l \times w \times h$ ). The dimensions of the axon model in the extra-cellular medium are shown in figure 3.



**Figure 3.** Geometrical model for simulation

### 3.2 Subdomain Settings

Two modes are used in the simulation, one for the axon and the other for extra-cellular medium as a coupled problem. In the PDE mode, the axon is considered as a subdomain with the dependent variables,  $u_1$  and  $u_2$ . The external medium is inactive. The PDE mode solves the following equation:

$$e_a \frac{\partial^2 u}{\partial t^2} + d_a \frac{\partial u}{\partial t} + \nabla \cdot \Gamma = F \quad (3)$$

where  $e_a$  - mass coefficient

$d_a$  - damping coefficient

$\Gamma$  - numerical flux

$F$  - source term

To build up equations (1) and (2) the following parameters are set to:

$$e_a = 0$$

$$d_a = 1$$

$$F = 0$$

The numerical flux  $\Gamma$  for equation (1) is set to:

$$\Gamma = \Delta u_1 + (\alpha - u_1)(u_1 - 1)u_1 + (-u_2) + I \quad (4)$$

and for equation (2) flux is set to:

$$\Gamma = \varepsilon(\beta u_1 - \gamma u_2 - \delta) \quad (5)$$

The initial conditions are assumed as:

$$u_1(t_0) = V_0 \cdot ((x + d) > 0) \cdot (z + d > 0) \quad (6)$$

$$u_2(t_0) = nu_0 \cdot ((-x + d) > 0) \cdot (z + d > 0) \quad (7)$$

This is to facilitate the simulation to observe a detailed initiation and propagation of AP in a specified region (for constants please see appendix).

The external medium is considered using the dependent variable  $V$  in electrostatic subdomain. The governing equation in the electrostatics-mode is:

$$-\nabla \cdot (\varepsilon_0 \varepsilon_r \nabla V) = \rho \quad (8)$$

Where  $V$  is the electric potential,  $\varepsilon_0$  is the permittivity of vacuum,  $\varepsilon_r$  is the relative permittivity and  $\rho$  is the spatial charge density. The extracellular medium is a physiological saline solution with a relative permittivity ( $\varepsilon_r$ ) of 80 and vanishing spatial charge density  $\rho$  of 0  $C/m^3$ .

### 3.3 Boundary Conditions

The potential distribution in the extracellular medium, which is described by the electrostatic form of the Maxwell equations, is solved using the Finite Element Method (FEM). The nonlinear differential equations describing the membrane behavior are coupled with the FEM solution using COMSOL Multiphysics® 3.5a. Coupling is achieved by setting the boundary conditions (BC) as given below. All boundaries of the tubular axon in the PDE subdomain are taken as Neumann BCs, satisfying the equation (9):

$$-n \cdot \Gamma = G \quad (9)$$

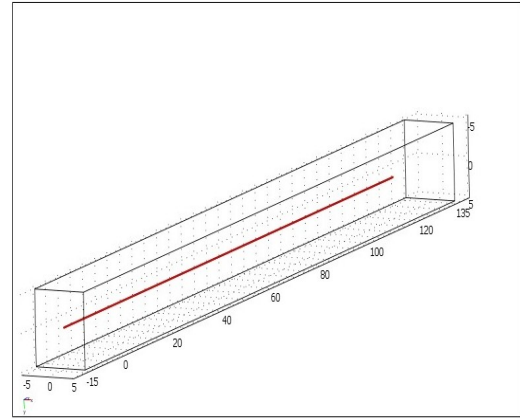
Where  $\Gamma$  - numerical flux

$G$  - source term

Here  $\Gamma$  is as in equation (4) and

$$G = 0$$

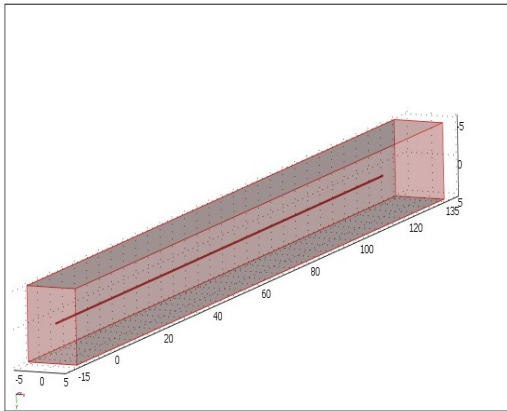
i.e. the normal component of the electric potential is zero. The figure below is a schematic diagram of the active boundary conditions in PDE mode.



**Figure 4.** BCs in the PDE-mode. The axon with Neumann BCs is marked in red.

In the electrostatics mode, all boundaries of the extra-cellular subdomain are at ground potential ( $V = 0$ ). The boundaries of the axon are chosen as electric potential sources with the coupling variable  $u_1$  ( $V = u_1$ ). The active BCs

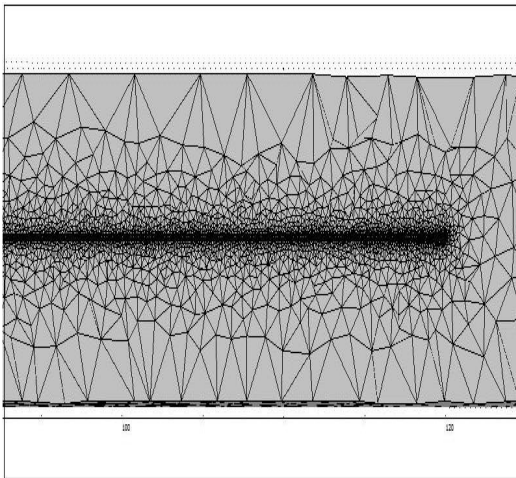
for the electrostatic mode are shown schematically in the following figure.



**Figure 5.** BCs in the electrostatics mode. Boundaries marked in red for the external block are set to ground and the axon to the actual electric potentials.

### 3.4 Mesh Generation

For the model, a tetrahedral mesh (Fig. 6) is used with a finer mesh around the axon and a coarser one in the external domain.



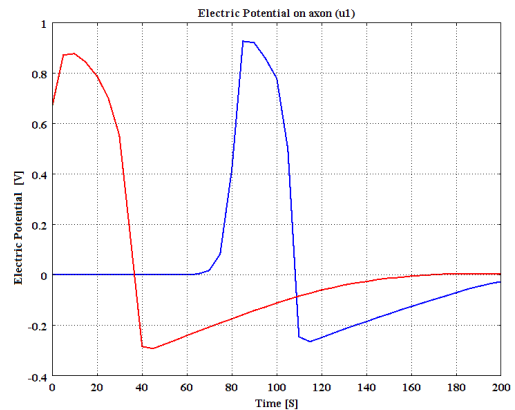
**Figure 6.** Cross-section of the meshed model.

The number of elements in the model is nearly 300,000. The number of degrees of freedom solved for the model was around 500,000 and the solution time was nearly 4200 s.

The time dependent solver was used to consider the temporal dynamics of the AP along the axon. The linear solver employed in this simulation was a 'Geometric multigrid', because the general solvers, such as DIRECT and GMRES failed to

solve the system due to nonlinearity and pre-conditioning problems.

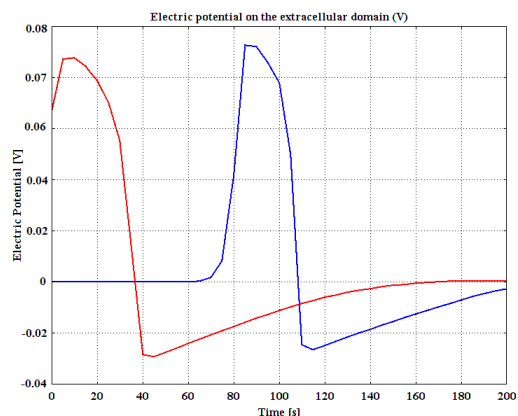
## 4. Post Processing



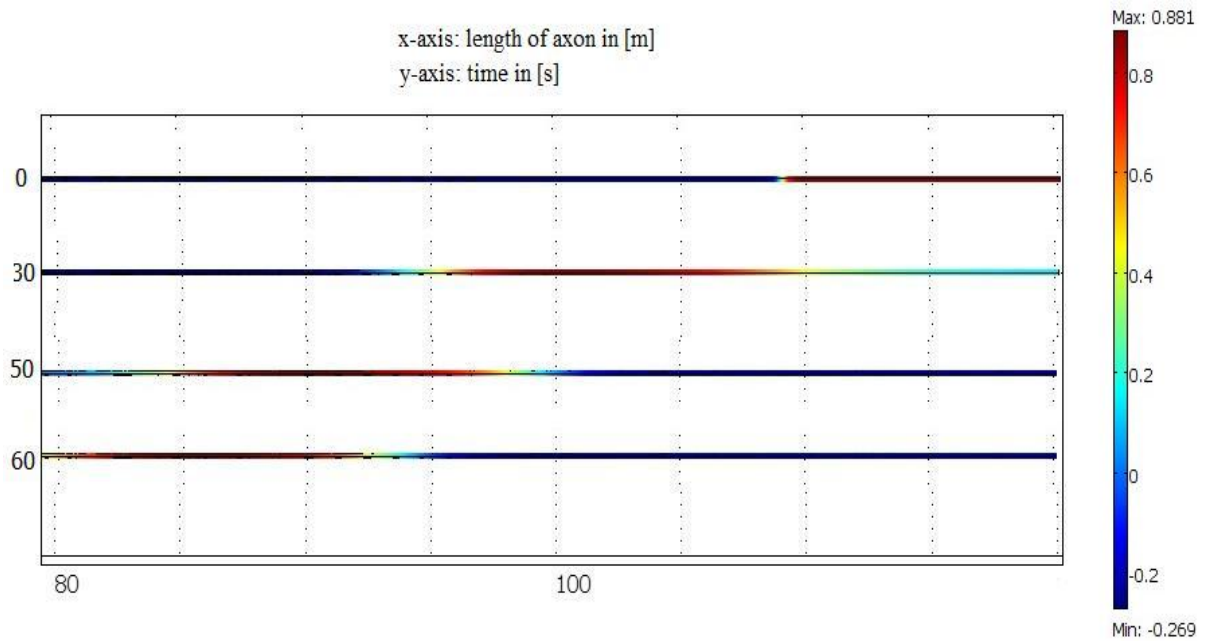
**Figure 7.** Action potentials on the axon at the starting (red) and ending points (blue) of the axon.

Figure 7 depicts the axonal AP obtained from the simulation. AP on the axon at the first points of axon and at the end points is plotted using the domain plot parameters (Fig.7). The simulation figure resembles the typical AP along an axon with respect to the spatial and temporal dynamics.

The electric potential change on a slice at a distance of 0.25 m (x-direction) away from the axon in the extracellular medium is plotted in the Fig. 8. The potential change in the extracellular medium is found to be similar as the AP in the axon (Fig. 7), however, with lesser magnitude of factor  $10e-1$ . This is due to the electrostatic formulation of the extracellular medium with its material properties.

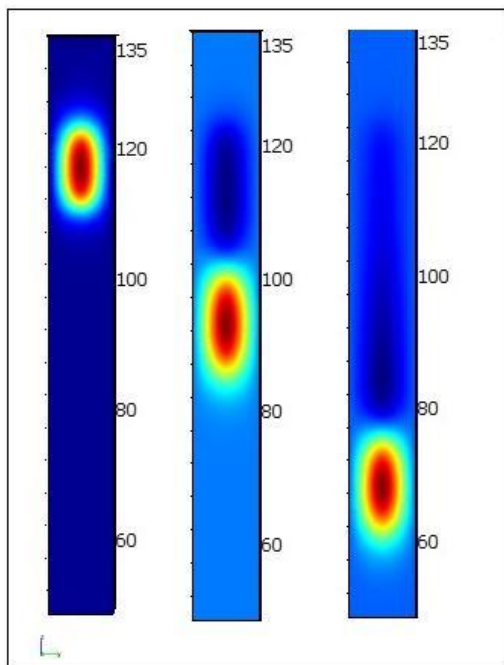


**Figure 8.** Electric potentials in the extracellular domain at starting (red) and ending points (blue) of the medium.



**Figure 9.** Action potential propagation in the axon at different times.

The propagation pattern of the AP in a sectional length of axon can be seen in the figure above (Fig. 9). Similarly, the extracellular potential change is observed as a voltage pulse traveling along the axon as can be seen in the following figure.



**Figure 10.** Electric potential observed on a slice of extra-cellular medium at times (a) 0, (b) 50 and (c) 100 (sectional length) with 0.08 V (Max) and -0.04 V (Min)

## 5. Discussion

We simulated a 3D axonal model of a Squid giant axon using the Fitzhugh-Nagumo equations to quantitatively validate the existing experimental data [1]. The present model is a first step in our neuron-electrode coupling project with a detailed electro-chemical model of neuron [6]. It is observed that the diameter and length of the axon affects the propagation velocity. A detailed study of these effects upon variations can be performed. The parameters of Fitzhugh-Nagumo equations effect the different phases of APs, its initiation and propagation. Based on the model, parametric studies will be carried out in future for specific dimensions and properties of the axon.

## 7. References

1. A. L. Hodgkin and A. F. Huxley, "A quantitative description of membrane current and its application to conduction and excitation in nerve", *Journal of Physiology*, vol. 117, pp. 500-544 (1952)
2. A. L. Hodgkin, "The ionic basis of nervous conduction", Nobel Lectures, Physiology or Medicine (1963-1970)
3. C. Koch, *Biophysics of computation: information processing in single neurons*, New York, NY [u.a.], Oxford Univ. Press, (1999)
4. R. Benz and F. Conti, Structure of squid axon membrane as derived from charge-pulse relaxation studies in the presence of absorbed lipophilic ions, *Journal of Membrane Biology*, vol. 59, pp. 91-104 (1981)

5. COMSOL Multiphysics® 3.5a Reference Manual, *PDE mode equation based modeling*, pp. 246-286

6. J. Flehr, Simulation des extrazellulären elektrischen Feldes von Nervenzellen während eines Aktionspotentials (Simulation of the extracellular electric field of nerve cells during an action potential), Dissertation, University of Rostock, (2006)

## 8. Acknowledgements

The authors are grateful to DFG (German Science Foundation) for funding our project in the Research Training Group 1505/1 welisa.

## 9. Appendix

Constants for Fitzhugh-Nagumo equations used in the simulation.

Name	Value	Description
$\alpha$	0.1	Excitation threshold [V]
$\beta$	0.75	Parameter
$\gamma$	1	Parameter
$\delta$	0	Parameter
$\varepsilon$	0.01	Excitability
$V_0$	1	Elevated potential [V]
$nu_0$	0.025	Elevated Relaxation value [V]
$d$	1	Off-axis shift distance [m]